

## Roll Up 28 WT

- EN** Instructions
- NL** Handleiding
- IT** Manuale
- SV** Bruksanvisning
- NO** Bruksanvisning
- DA** Brugsvejledning
- FI** Käyttöohje

Ref. 5122340A

HOME MOTION by  
**somfy**®



## CONTENTS

1. Prerequisite information	3	3. Use and maintenance	9
1.1 Fields of application	3	3.1. Up and Down buttons	9
1.2 liability	4	3.2. STOP function	9
2. Installation	5	4. Technical data	10
2.1. Installation	5		
2.2. Wiring	6		
2.3. Commissioning	7		
2.4. Tips and recommendations for installation	9		

## 1. PREREQUISITE INFORMATION

### 1.1 FIELDS OF APPLICATION

The Roll Up 28 WT is a motor specially dedicated to interior applications.

The Roll Up 28 WT can motorize roller blinds, sheer blinds, cellular blinds and pleated blinds.

The Roll Up 28 WT is a 24 V dc operated motor, powered by a power supply.

Warning : The Roll Up 28 WT cannot be used with sealed double glazing.

## 1.2 LIABILITY

Before installing and using the drive, please read **operating and installation guide carefully**. In addition to following the instructions given in this guide, the instructions detailed in the attached **Safety instructions** document must also be observed.

**The drive must be installed by a drive and home automation professional, according to instructions from Somfy and the regulations applicable in the country in which it is commissioned.**

It is prohibited to use the drive outside the fields of application described above. Such use, and any failure to comply with the instructions given in this guide and in the attached **Safety instructions** document, absolves Somfy of any liability and invalidates the warranty.

The installer must inform its customers of the operating and maintenance conditions for the drive and must provide them with the instructions for use and maintenance, and the attached **Safety instructions** document, after installing the drive. Any After-Sales Service operation on the drive must be performed by a drive and home automation professional.

If in doubt when installing the drive, or to obtain additional information, contact a Somfy adviser or go to the website [www.somfy.com](http://www.somfy.com)



Safety warning!



Caution!



Information

## 2. INSTALLATION

 Instructions which **must** be followed by the drive and home automation professional installing the Roll Up 28 WT drive.

 Never drop, knock, drill or submerge the drive.

 Install a separate control point for each drive.

### 2.1. INSTALLATION

#### 2.1.1. Preparing the drive

 Check that the inner diameter of the tube is 26,6 mm or greater.

1) Fit the accessories required to integrate the drive in the roller tube:

• Either fit the drive wheel **a** on the drive.

• Fit the crown **b** and the drive wheel **c** on the drive.

2) Measure the length (L) between the inner edge of the drive head and the rim of the drive wheel.

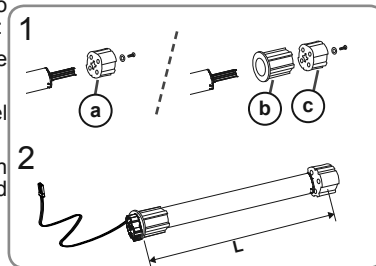

#### 2.1.2. Tube preparation

1) Cut the roller tube to the required length, depending on the motorised product.

2) Deburr the roller tube and remove the swarf.

3) For roller tubes which are smooth inside, cut a notch with the following measurements: **d** : 4 mm    **e** : 7 mm

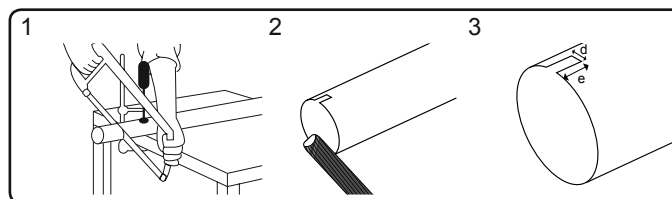

### 2.1.3. Drive/tube assembly

1) Slide the drive into the roller tube.

For roller tubes which are smooth inside, position the notch previously cut on the boss on the crown.

2) Fix the tube to the motor with self-tapping screws or steel pop rivets depending on the dimension (L).



The screws or pop rivets must only be attached to the drive wheel and not to the drive.

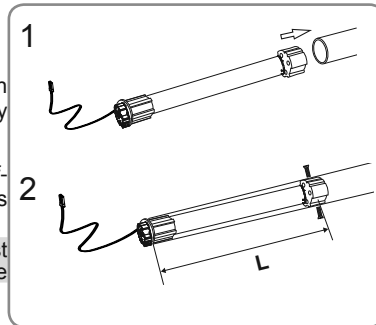

### 2.1.4. Installing the drive/tube assembly

Install and fix the drive/tube assembly onto the end bracket (f) and onto the drive bracket (g) :

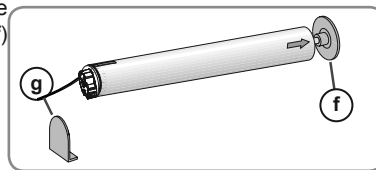

## 2.2 WIRING

Cables which pass through a metal wall must be protected and isolated using a sheath or sleeve.

Attach cables to prevent any contact with moving parts.

The cable for the Roll Up 28 WT cannot be removed. If it is damaged, return the drive to the After-Sales department.

- Switch off the power supply.
- Connect the drive according to the information in the table below:

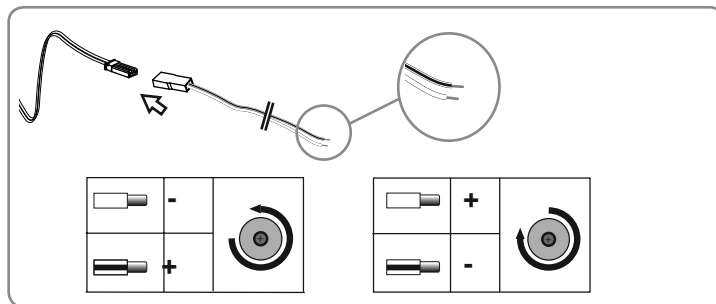

## 2.3. COMMISSIONING

### 2.3.1. Checking the direction of rotation

1) Switch the power back on.

2) Press the UP button on the control point:

a) If the motorised product rises (a), the direction of rotation is correct: Move onto the section entitled "Setting the end limits".

b) If the motorised product lowers (b), the direction of rotation is incorrect: Move onto the next step.

3) Switch off the power supply.

Reverse the 2 wires on the control point.

4) Switch the power back on.

Press the UP button on the control point to check the direction of rotation.

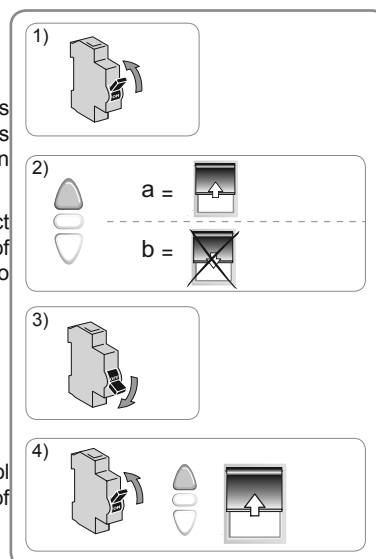

### 2.3.3. Setting the end limits

The end limits can be set in any order.

#### Setting the upper end limit

- 1) Press the UP button on the control point to raise the motorised product to the upper end limit.
- 2) Press the STOP button on the control point when the motorised product reaches the desired upper end limit.
- 3) Slide the "switch" corresponding to the upper end limit to record it.

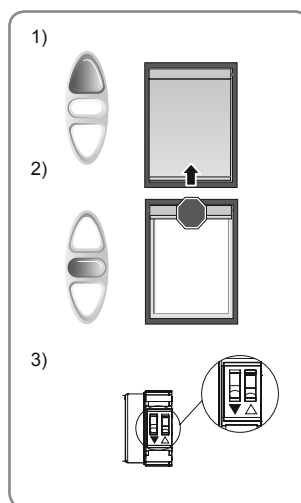

#### Setting the lower end limit

- 1) Press the DOWN button on the control point to lower the motorised product to the lower end limit.
- 2) Press the STOP button on the control point when the motorised product reaches the desired lower end limit.
- 3) Slide the "switch" corresponding to the lower end limit to record it.

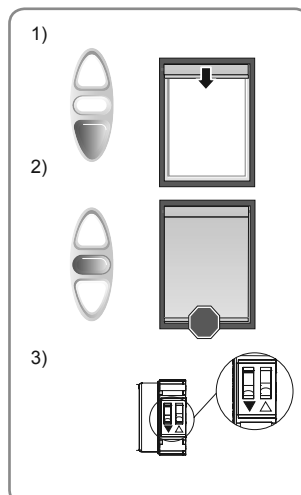



## 2.4. TIPS AND RECOMMENDATIONS FOR INSTALLATION

### 2.4.1. Questions about the Roll Up 28 WT?

Observations	Possible causes	Solutions
The motorised product does not operate.	The wiring is incorrect.	Check the wiring and modify it if necessary.
	The control point is not compatible.	Check for compatibility and replace the control point if necessary.
	The end limits are set at the same place.	Readjust the end limits.

## 3. USE AND MAINTENANCE

 This drive is maintenance-free

### 3.1. UP AND DOWN BUTTONS

Pressing the UP or DOWN button fully raises or lowers the motorised product.

### 3.2. STOP FUNCTION

The motorised product is moving.

- **Briefly** press the STOP button: the motorised product stops automatically.

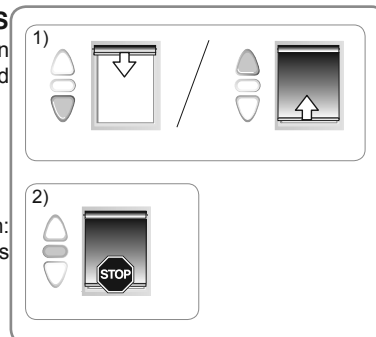

## 4. TECHNICAL DATA

Power supply	24 Vdc SELV
Torque	0.8 Nm
Up speed	28 rpm
Down speed	51 rpm
Electrical insulation	III
Maximum distance between two end-limit	60 turns
Maximum running time	6 min
Operating temperature	-10°C to + 85°C (Cf data sheet)
Protection rating	IP 30 (For indoor use only)



Somfy hereby declares that the product conforms with the essential requirements and other relevant provisions of the European Directives applicable for Europe. A Declaration of Conformity is available at [www.somfy.com/ce](http://www.somfy.com/ce).